

SPARTAN

LINEAR WL168



LED Zone 1 Linear Luminaire Standard and Emergency variants

The SPARTAN Linear range is designed specifically for use in new hazardous area installations or to retrofit existing fluorescent installations which require high performance, reliable, White-Light illumination. Housed in Marine Grade aluminium and using Raytec's field-proven, long-life LED technology, SPARTAN Linear is ATEX and IEC Ex approved for all Zone 1 applications and rated for T4, T5 and T6 environments (Zone 2 variants also available).

SPARTAN Linear's overall dimensions, fixing centres and gland entries are all compatible with commonly used traditional Ex e 2x36W fluorescent luminaires. The lumen output and light distribution also allows a direct, easy replacement of traditional fluorescent luminaires, meaning the customer can upgrade without complication and enjoy all the benefits of long life LED lighting while making regular lamp changes redundant.

SPARTAN Linear is available as an emergency variant, and standard variants can be converted to an emergency fitting at any time on-site, thanks to a unique modular design. This design also means key components can be easily accessed and serviced if required to make inspection and maintenance quicker and easier. SPARTAN Linear has a clear polycarbonate diffuser which is also available in various degrees of opaqueness to provide greater flexibility during installation.

SPARTAN uses **COOLEXTRUDE™** thermal management technology, ensuring a much cooler LED operating temperature and up to 60% better heat dissipation compared to traditional lighting solutions, allowing the product to operate for > 10 years while still delivering a high lumen output of up to 5,000 lumens.

Key Features

- ATEX and IEC Ex approved – Zone 1
UL/CSA approved, including C1D2
ABS approved
- Available as Zone 2 variant
- Retrofittable
- Ultra long life LED
- High lumen output LED
- Easy installation, maintenance and inspection
- Wide operating temperature range of -40° to +55°C
- Clear external tear off strips on outer optics available
- 5 year warranty

Why Raytec

- UK Designed & Manufactured
- Manufacturing precision engineered LED products
- Worldwide distributor support
- Lighting design and full technical support
- ISO9001 and ISO140001 accredited
- Award Winning Technology

Extended Features

Ultra-Powerful

High lumen output – up to 5,000 lumens
Latest high power LED technology

Retrofitable

Easy installation, matching the dimensions of traditional 2 x 36W fluorescent fittings, to provide an easy direct replacement
Equivalent Output to a 2x36W fluorescent

Ultra-Reliable

Industry leading 5 year warranty
Designed and manufactured in the UK to the highest standards including both ISO9001 & ISO14001
Advanced electronics and LED's protected by vibration resistant and waterproof potting compound

Ultra-Modular

Both the LED and PSU modules are easily accessible for maintenance and inspection
Available as a standard fitting only

Ultra-Efficient

COOLEXTRUDE™ thermal management delivers class leading energy efficiency
Significant running and maintenance savings compared to traditional lighting technologies
SMART access wiring system for safe and efficient installation, set-up and ongoing inspection

Ultra-Support

Photometric files available (.ies & .ldt)
Full Lighting Design Service
Site specific Energy and Cost Saving Report available

Product Dimensions

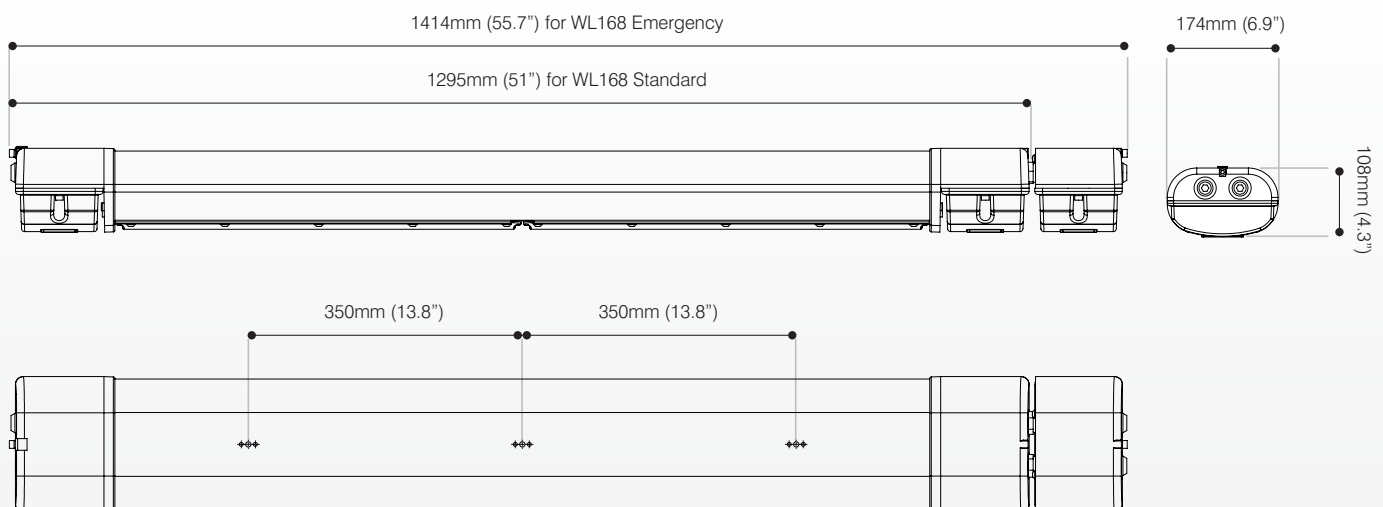

Technical Specifications

Certification

ATEX Rating: ATEX and IEC Ex rated for Gas and Dust
 Hazardous Area rating: Zone 1 & 2 – Gas and Dust
 Certificates: CML14ATEX3119 & IECEx CML 15.0001
 UL/CSA approved, including C1D2
 Gas: II 2 GD Ex emb IIC T5 or T4 Gb
 Ta -40°C to +55°C
 (-20°C to +50°C for emergency variants)
 II 2 GD Ex emb IIC T6 Gb
 Ta -40°C to +45°C
 (-20°C to +40°C for emergency variants)
 Dust: Ex tb IIIC T82°C Db
 IP66 & IP67 -
 Ta -40°C to +55°C
 (-20°C to +50°C for emergency variants)

Electrical

Input: 110-254V 50/60Hz AC only
 Low voltage option also available for standard variants only - 18-30V AC/DC
 Power: Standard - 68W
 Emergency - 71W
 Termination: Incoming terminal block at each end suitable for looping and through wiring 4 core 4mm² cable
 Power Factor: >0.95
 Cable entries: 2xM20 cable entries at both ends, through wired as standard (other entries available upon request), dispatched complete with three ATEX/IEC Ex approved blanking plugs

Optical

Lumen output on mains: Up to 5,000 lm
 LED type: Platinum SMT LEDs
 Number of LEDs: 168 LEDs
 CRI: 70+
 Colour Temperature: 6,000K+

Mechanical/Environmental

Burning position: Universal
 IP rating: IP66 & IP67
 Temperature range: -40°C to +55°C
 (-20°C to +50°C for emergency variants)
 Weight: Standard - 9kg (19.8lbs)
 Emergency - 10kg (22lbs)
 Enclosure: Marine grade aluminium epoxy powder coated, tough polycarbonate diffuser, all external fasteners and brackets are marine grade stainless steel
 Unit Colour: Silver (RAL 9006)
 Red (RAL3024) - Emergency cover
 Installation instructions: Raytec 920-M-0036
 Dimensions: Standard - 1295 x 108 x 174mm (51 x 4.3 x 6.9")
 Emergency - 1414 x 108 x 174mm (55.7 x 4.3 x 6.9")
 Mounting: Via M8 tapped holes. Various mounting arrangements available (please see product overview guide)

Emergency

Duration: Up to 3hrs @ 25% power
 Other options available
 Battery: Ni/Cd 12V
 Charge time: 20 hours

Part Codes





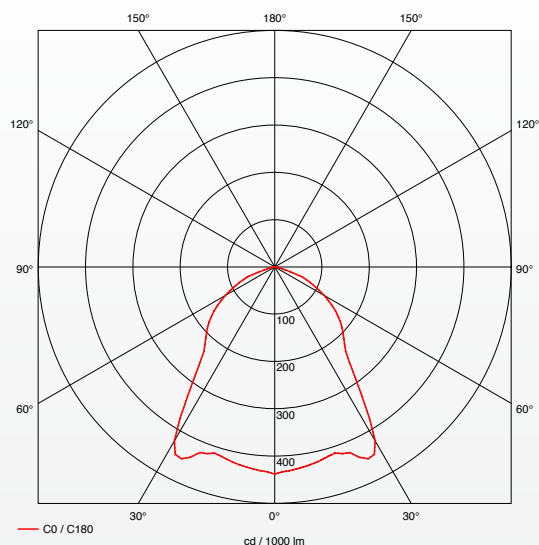

Part Codes	Description
SPX-WL168	SPARTAN Zone 1 Linear, 168 LED, White-Light
SPX-WL168-EM25	SPARTAN Zone 1 Linear, 168 LED, White-Light, Emergency Battery Backup

For low voltage versions add '-LV' to the above codes
 Contact Raytec for T5/T6 variants

Light Distribution



SPARTAN Linear Mounting Accessories

 <p>SUSPENSION CORD KIT</p>	 <p>POLE CLAMP KIT</p>	 <p>M8 EYE BOLT</p>
<p>SPX - BKT - SC500 (500mm Long, Stainless Steel) SPX - BKT - SC1000 (1000mm Long, Stainless Steel) SPX - BKT - SC1500 (1500mm Long, Stainless Steel)</p>	<p>SPX - BKT - PC3841 (38-41mm Diameter, Stainless Steel) SPX - BKT - PC4245 (42-45mm Diameter, Stainless Steel) SPX - BKT - PC4851 (48-51mm Diameter, Stainless Steel) SPX - BKT - PC5457 (54-57mm Diameter, Stainless Steel) SPX - BKT - PC5962 (59-62mm Diameter, Stainless Steel)</p>	<p>SPX - BKT - EYE (Stainless Steel)</p>
 <p>CEILING MOUNTING KIT</p>	 <p>SWIVEL MOUNT KIT</p>	 <p>WALL MOUNTING OUTREACH BRACKET</p>
<p>SPX - BKT - CM (Stainless Steel)</p>	<p>SPX - BKT - SW (30° and 45° Increments, Stainless Steel)</p>	<p>SPX - BKT - WMOB84 SPX - BKT - WMOB168</p>

Other accessories also available, including Magnetic Mounting Kit (SPX-BKT-MAG) and Tear off Optic Strips – pack of 10 (SPX-BKT-PF84).

Products in the SPARTAN Linear WL168 range

SPARTAN Zone 1
Linear WL168



SPARTAN Zone 2
Linear WL168



SPARTAN Industrial
Linear WL168



Other Products in the SPARTAN Hazardous Area Family

SPARTAN Flood 12



SPARTAN Flood 48



SPARTAN Bulkhead 24

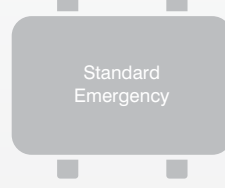

SPARTAN Linear WL84
2 x 18W equivalent

SPARTAN Linear WL168
2 x 36W equivalent

