

SPARTAN

SAFETY SHOWER LINEAR



LED Zone 1 Safety Shower Linear Luminaire

The SPARTAN Safety Shower Linear is designed specifically for use in new hazardous area installations or to retrofit existing fluorescent installations where a safety shower unit is located. Housed in marine grade aluminium and using Raytec's field proven, long-life LED technology, SPARTAN Safety Shower Linear is ATEX and IEC Ex approved for all Zone 1 applications and rated for T4, T5 and T6 environments (Zone 2 variants also available).

SPARTAN Safety Shower Linear uses green, long-life LEDs and comes with an industry leading 5 year warranty for a high performance, reliable, low maintenance solution. SPARTAN Safety Shower Linear's overall dimensions, fixing centres and gland entries are all compatible with commonly used traditional Ex e fluorescent luminaires. The lumen output and light distribution also allows a direct, easy replacement of traditional fluorescent luminaires, meaning the customer can upgrade without complication and enjoy all the benefits of long life LED lighting while making regular lamp changes redundant and removing the need to rely on green-coloured lens films that are susceptible to peeling and fading.

SPARTAN Safety Shower Linear's unique modular design means key components can be easily accessed and serviced if required to make inspection and maintenance quicker and easier.

SPARTAN uses **COOLEXTRUDE™** thermal management technology, ensuring a much cooler LED operating temperature and up to 60% better heat dissipation compared to traditional lighting solutions, allowing the product to operate for > 10 years.

Key Features

- ATEX & IEC Ex approved – Zone 1
UL/CSA approved, including C1D2
ABS and EAC approved
- Zone 2 variant also available
- Retrofittable
- Green, long life LEDs
- Easy installation, maintenance and inspection
- Wide operating temperature range of -40°C to +55°C
- Clear external tear off strips on outer optics available
- 5 year warranty

Why Raytec

- UK Designed & Manufactured
- Manufacturing precision engineered LED products
- Worldwide distributor support
- Lighting design and full technical support
- ISO9001 and ISO140001 accredited
- Award Winning Technology

Extended Features

Retrofitable

Easy installation, matching the dimensions of traditional fluorescent fittings, to provide an easy direct replacement

Ultra-Reliable

Industry leading 5 year warranty

Designed and manufactured in the UK to the highest standards including both ISO9001 & ISO14001
Advanced electronics and LED's protected by vibration resistant and waterproof potting compound

Ultra-Modular

Both the LED and PSU modules are easily accessible for maintenance and inspection

Ultra-Efficient

COOLEXTRUDE™ thermal management delivers class leading energy efficiency

Significant running and maintenance savings compared to traditional lighting technologies

SMART access wiring system for safe and efficient installation, set-up and ongoing inspection

Ultra-Support

Photometric files available (.ies & .ldt)

Full Lighting Design Service

Site specific Energy and Cost Saving Report available

Product Dimensions

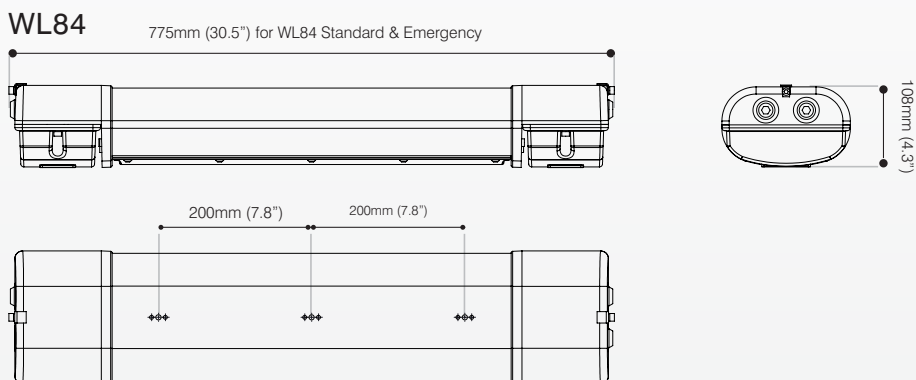
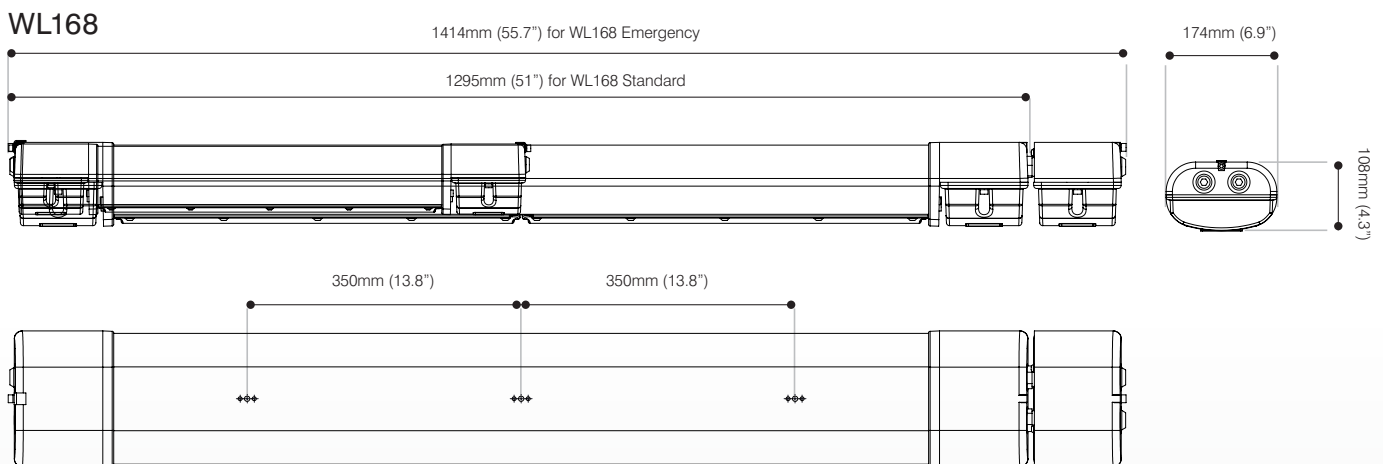

Technical Specifications

Certification

ATEX Rating:	ATEX and IEC Ex rated for Gas and Dust
Hazardous Area rating:	Zone 1 – Gas and Dust
Certificates:	CML14ATEX3119 & IECEx CML 15.0001 ABS Certificate # 15-LD1364539-1-PDA UL/CSA, including C1D2
Gas:	II 2 GD Ex emb IIC T5 or T4 Gb Ta -40°C to +55°C (-20°C to +50°C for emergency variants) II 2 GD Ex emb IIC T6 Gb Ta -40°C to +45°C (-20°C to +40°C for emergency variants)
Dust:	Ex tb IIIC T82°C Db IP66 & IP67 - Ta -40°C to +55°C (-20°C emergency variants)

Electrical

Input:	110-254V 50/60Hz AC only Low voltage option also available for standard variants only - 18/30V AC/DC
Power:	WL84 Standard - 34W WL84 Emergency - 37W WL168 Standard - 68W WL168 Emergency - 71W
Termination:	Incoming terminal block at each end suitable for looping and through wiring 4 core 4mm ² cable
Power Factor:	>0.95
Cable entries:	2xM20 cable entries at both ends, through wired as standard (other entries available upon request), dispatched complete with three ATEX/IEC Ex approved blanking plugs

Optical

LED type:	Platinum SMT LEDs
Number of LEDs:	84 LEDs
CRI:	70+
Colour:	Green
Dominant Wavelength:	519nm (true green)

Mechanical/Environmental

Burning position:	Universal
IP rating:	IP66 & IP67
Temperature range:	-40°C to +55°C (-20°C to +50°C for emergency variants)
Weight:	WL84 Standard - 6kg (13.2lbs) WL84 Emergency - 7kg (15.4lbs) WL168 Standard - 9kg (19.8lbs) WL168 Emergency - 10kg (22lbs)
Enclosure:	Marine grade aluminium epoxy powder coated, tough polycarbonate diffuser, all external fasteners and brackets are marine grade stainless steel
Unit Colour:	Silver (RAL 9006) Red (RAL3024) - Emergency cover
Installation instructions:	Raytec 920-M-0036
Dimensions:	WL84 Standard and Emergency - 775 x 108 x 174mm (30.5 x 4.3 x 6.9") WL168 Standard - 1295 x 108 x 174mm (51 x 4.3 x 6.9") WL168 Emergency - 1414 x 108 x 174mm (55.7 x 4.3 x 6.9")
Mounting:	Via M8 tapped holes. Various mounting arrangements available (please see product overview guide)
Emergency	
Duration:	Up to 3hrs @ 25% power Other options available
Battery:	Ni/Cd 12V
Charge time:	20 hours

Part Codes

Part Codes	Description
SPX-WL84-G (2x18W replacement)	SPARTAN Zone 1 Safety Shower Linear WL84
SPX-WL84-G-EM25	SPARTAN Zone 1 Safety Shower Emergency Linear WL84
SPX-WL168-G (2x36W replacement)	SPARTAN Zone 1 Safety Shower Linear WL168
SPX-WL168-G-EM25	SPARTAN Zone 1 Safety Shower Emergency Linear WL168





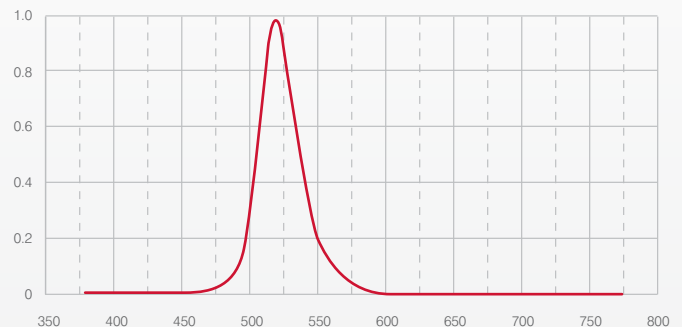

Dominant Wavelength

Optical

LED type:	Platinum SMT LEDs
Dominant Wavelength:	519nm (true green) 



SPARTAN Linear Accessories

 <p>SUSPENSION CORD KIT</p>	 <p>POLE CLAMP KIT</p>	 <p>M8 EYE BOLT</p>
<p>SPX - BKT - SC500 (500mm Long, Stainless Steel) SPX - BKT - SC1000 (1000mm Long, Stainless Steel) SPX - BKT - SC1500 (1500mm Long, Stainless Steel)</p>	<p>SPX - BKT - PC3841 (38-41mm Diameter, Stainless Steel) SPX - BKT - PC4245 (42-45mm Diameter, Stainless Steel) SPX - BKT - PC4851 (48-51mm Diameter, Stainless Steel) SPX - BKT - PC5457 (54-57mm Diameter, Stainless Steel) SPX - BKT - PC5962 (59-62mm Diameter, Stainless Steel)</p>	<p>SPX - BKT - EYE (Stainless Steel)</p>
 <p>CEILING MOUNTING KIT</p>	 <p>SWIVEL MOUNT KIT</p>	 <p>WALL MOUNTING OUTREACH BRACKET</p>
<p>SPX - BKT - CM (Stainless Steel)</p>	<p>SPX=BKT-SW (30° and 45° Increments, Stainless Steel)</p>	<p>SPX - BKT - WMOB84 SPX - BKT - WMOB168</p>

Other accessories also available, including Magnetic Mounting Kit (SPX-BKT-MAG) and Tear Off Optic Strips - pack of 10 (SPX-BKT-PF84)

Products in the SPARTAN Safety Shower Linear range

SPARTAN Zone 1 Safety Shower
Linear WL84

SPARTAN Zone 2 Safety Shower
Linear WL84

SPARTAN Zone 1 Safety Shower
Linear WL168

SPARTAN Zone 2 Safety Shower
Linear WL168



Other Products in the SPARTAN Hazardous Area Family

SPARTAN Flood 12



SPARTAN Flood 48



SPARTAN Bulkhead 24



SPARTAN Linear WL84
2 x 18W equivalent

SPARTAN Linear WL168
2 x 36W equivalent

